



标准&定制开关连接器产品制造商
DONG GUAN XI BANG ELECTRONICS CO., LTD.

规格书

SPECIFICATION

CUSTOMER NAME 客户名称: _____
 CUSTOMER NO. 客户编号: _____
 SERIES 系列: 轻触开关
 MODEL NO. 型号: XB-TFZT10 3X6X2.5 贴片 拉伸盖一型
 DRAWING NO. 图形号: Tact Switches

If specification of this product meets your request, please confirm all the items of it and return to us with signature and stamp, it will be basis of our production and record. Thanks your cooperation in advance!

若此产品规格符合贵司要求，敬请确认此规格书内所有项目
 并签名和盖章后回传给我司，以作我司产品制作之
 依据和存档之用，多谢合作！

EXAMINE & APPROVAL 审批

APPROVE 接受	NOT APPROVE 不接受
SIGNATURE 签署 STAMP 盖章 DATE 日期	

PREPARED BY. 制表人	CHECKED BY. 校对	APPROVED BY. 审核	APPROVAL BY. 批准
<div style="border: 1px solid red; padding: 2px;">研发部</div> <div style="border: 1px solid red; padding: 2px;">戴海明</div> <div style="border: 1px solid red; padding: 2px;">2022. 06. 08</div>	<div style="border: 1px solid red; padding: 2px;">品质部</div> <div style="border: 1px solid red; padding: 2px;">黄自清</div> <div style="border: 1px solid red; padding: 2px;">2022. 06. 08</div>	<div style="border: 1px solid red; padding: 2px;">工程部</div> <div style="border: 1px solid red; padding: 2px;">庞军</div> <div style="border: 1px solid red; padding: 2px;">2022. 06. 08</div>	<div style="border: 1px solid red; padding: 2px;">总经办</div> <div style="border: 1px solid red; padding: 2px;">吴量</div> <div style="border: 1px solid red; padding: 2px;">2022. 06. 08</div>

东莞市溪榜电子有限公司

Dong guan Xi Bang Electronics Co., Ltd

地址: 广东省东莞市黄江镇合路工业区
 Address: He Lu Industrial Zone, Huangjiang Town
 , Dongguan City, Guangdong Province
 Tel: (0769)82055138/82056828
 Fax: (0769)83663452

邮箱: admin@alspr.com switch@alspr.com
<http://www.alspr.cn/> <http://www.alspr.com/>

Dong Guan XB Electronics Co., Ltd

Account Number: 705540238
 Bank Name: Citibank N. A., Hong Kong Branch
 Country/Region: Hong Kong
 Bank Code: 006
 Bank Address: 3 Garden Road, Central, Hong Kong
 SWIFT/BIC: CITIHKHX (CITIHKHXXXX*If 11 characters are required)

MAil: HK@ALPSR.CN XB@ALPSR.CN
 Quality core! Afterburner for Made in China!

H:	2.5	3.5	5.0
A:	0.6	0.7	
B:	A+0.4		

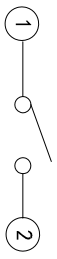
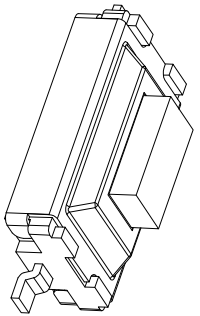
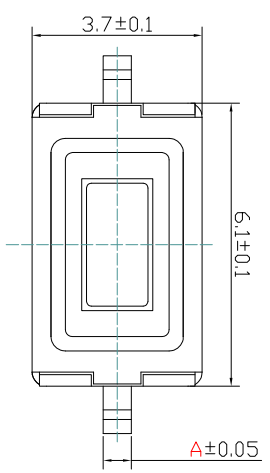
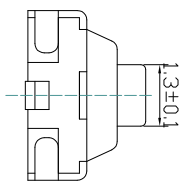
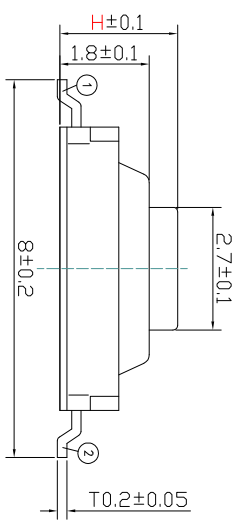

CIRCUIT DIAGRAM

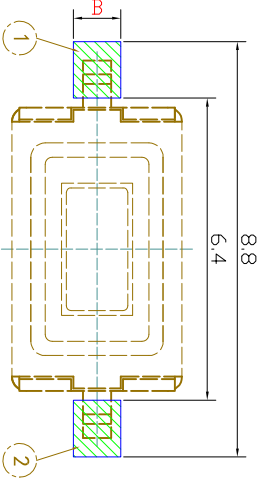

P.C.B MOUNTING PATTERN DIMENSION
The following soldering are recommended for reflow soldering

标 记 MARK	ECN编号/变更内容 ECN NO./DEFINITION	日 期 DATE	修 改 REVISE	核 准 APPROVE

项 目	规 格	未标注公差列表		单 位: UNIT	mm	产 品 系 列 Product series	轻 触 开 关
额定电负荷:	DC12V 50mA	X.	±0.2	X.°	±1°	材 质 MATERIAL	
绝缘电阻:	≥100MΩ 100V DC/1min	.X	±0.1	X°	±0.5°	重 量 WT.	
耐压强度:	AC250V 50Hz/1min	.XX	±0.05	.XX°	±0.3°	图 号	
环境温度:	-40℃ ~ +85℃	.XXX	±0.02	.XXX°	—	设计 DESIGN	
接触电阻:	≤100mΩ Max	审核 CHECKED				视图 VIEW	比例 SCALE
行 程:	0.25±0.1mm	校核 STANDARD				图 号 DWG NO.	1 : 1
		批准 APPROVE				日期 DATE	2020/03
				版本 REV.	A0	东 莞 市 溪 榜 电 子 有 限 公 司 DONG GUAN XI BANG ELECTRONI CS CO., LTD.	
				张 数		第 页	

规格承认书

SPECIFICATION FOR APPROVAL

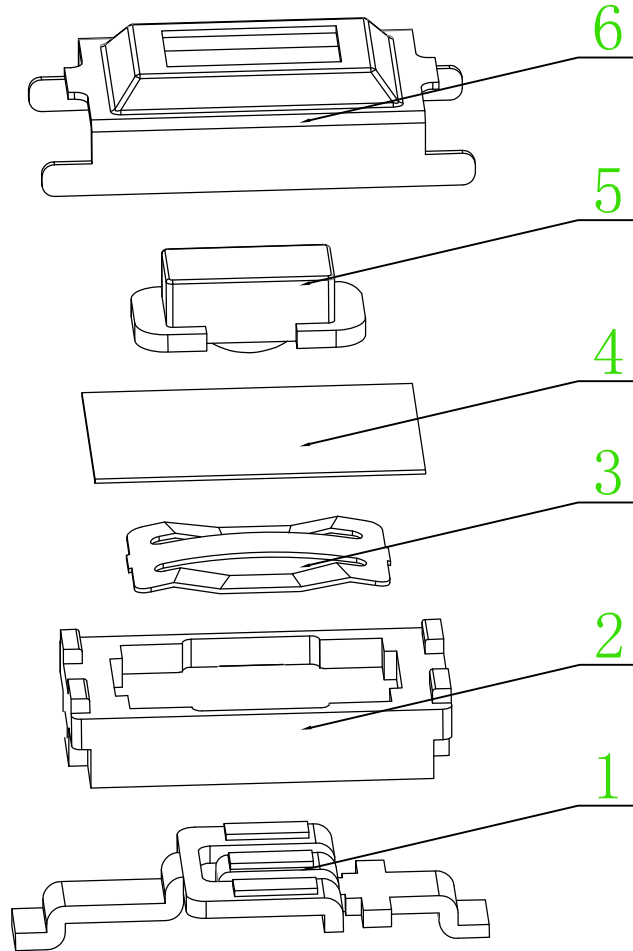

序号 NO.	零部件名称 NAME	材料名称 MATERIAL	数量 QUANTITY	备注 REMARKS
1	卡件 TERMINAL	磷铜 PHOSPHOR COPPER	1	镀银 Ag PLATED
2	基座 CASE	LCP/PPA	1	白/黑色 WHITE/BLACK
3	弹片 CONTACT	SUS301	1	镀银 Ag PLATED
4	防尘膜 SEAL PLATE	聚酰亚胺 PI	0/1	黄色 YELLOW
5	按钮 STEM	LCP/PPA	1	白/黑色 WHITE/BLACK
6	盖板 COVER	SUS304	1	清洗 CLEANOUT

规格承认书

SPECIFICATION FOR APPROVAL

1. General characteristics 一般特性:

1.1 Application 适用范围:

This specification is applied to the requirements for TACT SWITCH (MECHANICAL CONTACT)

本规范适用于轻触开关(机械接触)的要求

1.2 Operating Temperature Range 使用温度范围

-40to+85°C (normal humidity, normal pressure.) 正常湿度, 标准压力

1.3 Storage Temperature Range 保存温度范围

-40to+85°C (normal humidity, normal pressure.)

1.4 Test Conditions 测试条件

Tests and measurements shall be made in the following standard conditions unless otherwise specified:

除特殊说明外, 测试和计量应按下列标准条件:

Normal temperature (5 to 35°C) 标准温度: 5 to 35°C

Normal humidity (relative humidity 45 to 85%) 相对湿度: 45 to 85%

Normal pressure (860 to 1060mbars) 标准压力: 860 to 1060毫巴

In case any question arises from the judgment made, tests shall be conducted in the following conditions:

如有影响判断, 应在下列条件下进行测试:

Temperature : (20±2°C) 温度: 20±2°C:

Relative humidity : (65±5%) 相对湿度: 65±5%

Pressure : (860 to 1060mbars) 压力: 860 to 1060mbars

2. Switch action (开关动作): Tactile feedback 轻触返回

3. The contact form (接触形式): 1 contact 1 circuit 1接点1回路

4. Maximum Ratings(最大额定值): DC 12 V 50 mA

规格承认书

SPECIFICATION FOR APPROVAL

5.General specification 性能

5.1 Initial mechanical Characteristics初始电气性能:

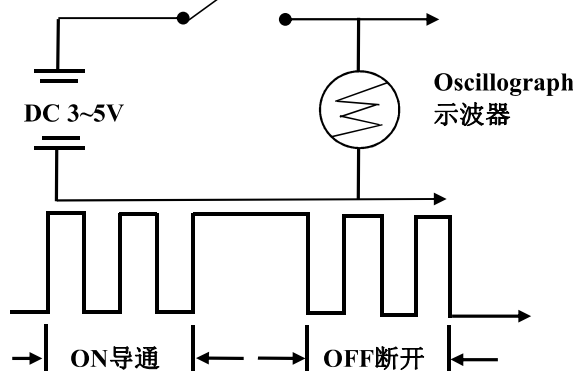
Item项目		Test Method试验方法	Criteria 标准
5.1.1	Contact Resistance 接触电阻	USE 2 TIMES THE LOAD AT 1KHZ MINUTE CURRENT (100mA BELOW).. 用2倍的负载在1KHZ微小电流(100mA 以下)测试.	100mΩ MAX. 100毫欧以下
5.1.2	Insulation Resistance 绝缘电阻	APPLY A VOLTAGE OF 100V DC SHALL BE APPLIED FOR 1 MIN AFTER WHICH MEASUREMENT BE MADE: (1) BETWEEN TERMINALS. (2) BETWEEN INDIVIDUAL TERMINALS AND FRAME. 输入100V DC 电压1分钟,按以下接触方法测试: (1) 端子相互之间. (2) 端子与外壳之间.	100MΩ MIN. 100兆欧以上
5.1.3	Dielectric voltage 抗电强度	AC 250V (50-60Hz) FOR 1 MIN TRIP CURRENT: 0.5mA (1) BETWEEN TERMINALS. (2) BETWEEN INDIVIDUAL TERMINALS AND FRAME. 输入AC 250V(50-60Hz)电压,1分钟感度电流为0.5mA,按以下接触方法测试: (1) 端子相互之间. (2) 端子与外壳之间 .	NO INSULATION DAMAGE AND OTHER ANOMALIES 没有绝缘性破坏等异常.
5.1.4	Shake 抖动 (When necessary 必要时)	LIGHTLY STRIKING THE CENTER OF THE STEM AT A RATE ENCOUNTERED IN NORMAL USE (3 TO 4 OPERATIONS PER SEC),BOUNCE SHALL BE TESTED WHEN "ON" AND "OFF". 在正常使用中(以每秒3-4次周期)轻轻地在手柄中心加力,在通与断瞬间测试抖动 	10mS以下

规格承认书

SPECIFICATION FOR APPROVAL

5.2 Mechanical Characteristics机械性能

Item项目		Test Method试验方法	Criteria 标准
5.2.1	Operating Force 操作力	<p>THE FORCE IS APPLIED TO THE FRONT END OF THE HANDLE TO MEASURE THE FORCE FROM THE INITIAL POSITION TO THE POSITION OF THE ACTION</p> <p>沿着动作的方向将力施加于手柄前端，测量从自由位置到动作位置所需的力</p>	<p>Push force 按压力</p> <p>1.0±0.3N (100±30gf) <input type="checkbox"/></p> <p>1.2±0.3N (120±30gf) <input type="checkbox"/></p> <p>1.6±0.3N (160±30gf) <input type="checkbox"/></p> <p>2.5±0.5N (250±50gf) <input type="checkbox"/></p>
5.2.2	Return Force 回复力	<p>THE SAMPLE SWITCH IS INSTALLED SUCH THAT THE DIRECTION OF SWITCH OPERATION IS VERTICAL AND, UPON DEPRESSION OF THE STEM IN ITS CENTER THE WHOLE TRAVEL DISTANCE, THE FORCE OF THE STEM TO RETURN TO ITS FREE POSITION SHALL BE MEASURED.</p> <p>开关的动作方向为垂直放置开关,在已有行程的推柄的中心向上减小压力,推柄返回到自由位置时所测量到的力</p>	<p>Return force 回弹力 大于按压力的30%</p>
5.2.3	Operation Travel 操作行程	<p>USE 2 TIMES STATIC LOAD TO MEASURE THE DISTANCE FROM THE FREE POSITION TO THE ACTION POSITION ALONG THE MOVEMENT DIRECTION</p> <p>沿着动作的运行方向，使用2倍的静负荷来测量从自由位置到动作位置的距离</p>	<p>REFERENCE PRODUCT DRAWINGS 参考产品图纸</p>
5.2.4	Strength of Actuator (Knob) 柄强度	<p>PLACING THE SWITCH SUCH THAT THE DIRECTION OF SWITCH OPERATION IS VERTICAL, A STATIC LOAD OF 3kgf SHALL BE APPLIED IN THE DIRECTION OF STEM OPERATION FOR A PERIOD OF 15SECONDS.</p> <p>开关的动作方向为垂直放置开关,在推柄的动作方向施加3kgf的静负荷15秒时间</p>	<p>NO SIGNS OF MECHANICAL OR ELECTRICAL DAMAGE 无机械的和电气的损伤迹象</p>
5.2.5	Terminal Strength 端子强度	<p>A STATIC LOAD OF 250gf SHALL BE APPLIED TO THE TERMINAL FOR 10 SEC.IN ANY DIRECTION</p> <p>在端子前端任意一个方向加250gf力度测试,时间为10秒</p>	<p>THE TERMINAL HAS NO LOOSENESS, CRACK, ETC., MECHANICAL AND ELECTRICAL CHARACTERISTICS SHALL BE SATISFIE 端子无松动、裂开异常，满足机械、电气性能。</p>

规格承认书

SPECIFICATION FOR APPROVAL

5.3 Durability 使用耐久性

Item项目	Test Method试验方法	Criteria 标准
5.3.1	<p>Operating Life 操作寿命</p> <p>THERE IS NO LOAD:无负荷</p> <p>(1) RATE OF OPERATION: 1 TO 2 OPERATIONS PER SECOND 动作频率: 2次/每秒</p> <p>(2) OPERATING FORCE: 1.5 TIMES gf Max. 1.5倍力最大</p> <p>(3) CYCLES OF ACTIONS 动作次数: 30,000次 <input type="checkbox"/> 50,000次 <input type="checkbox"/></p>	<p>(1) CONTACT RESISTANCE (接触电阻)200mΩ MAX.200毫欧以下。</p> <p>(2) INSULATION RESISTANCE(绝缘电阻) 50MΩ MIN. 50兆欧以上。</p> <p>(3) WITHSTAND VOLTAGE(耐电压): AC 250V,1 MINUTE. AC 250V 1分钟.</p> <p>(4) OPERATING FORCE(作动力) :±30% INITIAL VALUE. 变化范围: 初始值±30%.</p> <p>(5) MECHANICAL AND ELECTRICAL CHARACTERISTICS SHALL BE SATISFIED 满足机械、电气性能.</p>
5.3.2	<p>Vibration Resistance 抗振性</p> <p>MEASUREMENTS SHALL BE MADE FOLLOWING THE TEST SET FORTH BELOW: 按下列条件进行抗振动试验</p> <p>(1)RANGE OF OSCILLATION:10 TO 55HZ 频率范围</p> <p>(2)AMPLITUDE,PK-TO-PK:1.5 MM . 振幅: 峰-峰1.5MM.</p> <p>(1)CYCLE OF SWEEP: 10-55-10HZ IN ONE MINUTE APPROX. 扫描周期: 10-55-10HZ 约一分钟内</p> <p>(2)MODE OF SWEEP: LOGARITHMICALLY SWEEP OR UNIFORM SWEEP. 扫描方式:对数扫描式恒定扫描</p> <p>(5)DIRECTION OF OSCILLATION: THREE MUTUALLY PERPENDICULAR DIRECTIONS, INCLUDING THE DIRECTION OF STEM TRAVEL. 振动方向: 3个相互垂直方向,包括推柄行程方向</p> <p>(6)1 HOURS EACH ,FOR A TOTAL OF 3HOURS. 每个方向1小时.共3小时</p>	<p>NO SIGNS OF MECHANICAL OR ELECTRICAL DAMAGE 无机械的和电气的损伤迹象</p>

规格承认书

SPECIFICATION FOR APPROVAL

5.4 Weather Proof Characteristics 耐候性能

Item项目	Test Method试验方法	Criteria 标准
5.4.1 Moisture Resistance 耐潮湿	<p>THE SAMPLES WERE TESTED FOR MOISTURE RESISTANCE UNDER THE FOLLOWING CONDITIONS. AFTER THE TEST, THE TEST WAS CONDUCTED WITHIN 1 HOUR AFTER THE NORMAL TEMPERATURE AND HUMIDITY: 按下列条件对样品进行耐潮湿试验,试验后在正常温度和湿度条件下放置1小时后测定</p> <p>(1)TEMPERATURE: 60±2℃ 温度 (2)RELATIVE HUMIDITY: 90 TO 95% 相对湿度 (3)TIME: 96 HOURS 时间</p> <p>WATER DROPS SHALL BE REMOVED. 擦除水珠</p>	<p>THERE SHALL BE NO DAMAGE ON APPEARANCE. MECHANICAL AND ELECTRICAL CHARACTERISTICS SHALL BE SATISFIED. 外观无异常,满足于机械,电气性能。</p>
5.4.2 Low Temperature Resistance 耐低温性	<p>THE SAMPLES WERE TESTED IN LOW TEMPERATURE ACCORDING TO THE FOLLOWING CONDITIONS. AFTER THE TEST, THE TEST WAS CONDUCTED AFTER AN HOUR OF NORMAL TEMPERATURE AND HUMIDITY: 按下列条件对样品进行耐低温试验,试验后在正常温度和湿度条件下放置1小时后测定</p> <p>(1)TEMPERATURE: -40±3℃ 温度 (2) TIME: 96 HOURS 时间</p> <p>WATER DROPS SHALL BE REMOVED. 擦除水珠</p>	<p>THERE SHALL BE NO DAMAGE ON APPEARANCE. MECHANICAL AND ELECTRICAL CHARACTERISTICS SHALL BE SATISFIED. 外观无异常,满足于机械,电器性能。</p>
5.4.3 Heat Resistance 耐热性	<p>THE SAMPLES ARE TESTED FOR HEAT RESISTANCE ACCORDING TO THE FOLLOWING CONDITIONS. AFTER THE TEST, THE TEST IS DETERMINED AFTER AN HOUR OF NORMAL TEMPERATURE AND HUMIDITY: 按下列条件对样品进行耐热试验,试验后在正常温度和湿度条件下放置1小时后测定</p> <p>(1)TEMPERATURE: 85±2℃ 温度 (2)TIME: 96 HOURS 时间</p>	<p>THERE SHALL BE NO DAMAGE ON APPEARANCE. MECHANICAL AND ELECTRICAL CHARACTERISTICS SHALL BE SATISFIED. 外观无异常,满足于机械,电器性能。</p>

规格承认书

SPECIFICATION FOR APPROVAL

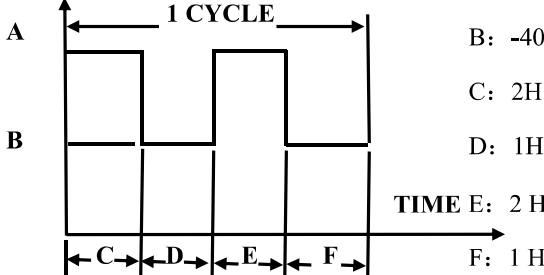
Item项目	Test Method试验方法	Criteria 标准
5.4.4	<p>SAMPLES UNDER THE FOLLOWING CONDITIONS FOR HIGH AND LOW TEMPERATURE CYCLING TEST, AFTER THE TEST AT NORMAL TEMPERATURE AND TEMPERATURE CONDITIONS FOR 1 HOUR AFTER THE TEST.</p> <p>样品按下列条件进行高低温循环试验,试验后在正常温度和温度条件下放置1小时后测定</p> <p>TEMP(°C)</p> <p>A: $+85\pm 2^{\circ}\text{C}$ B: $-40\pm 2^{\circ}\text{C}$ C: 2H D: 1H E: 2H F: 1H</p>  <p>CYCLING: FIVE CYCLES 周期: 5次</p>	<p>Contact resistance: 200 mΩ Max. 接触电阻 Insulation resistance : 50 MΩ Min. 绝缘电阻 NO SIGNS OF MECHANICAL OR ELECTRICAL DAMAGE 无机械的和电气的损伤迹象</p>
5.4.5	<p>THE SALT SPRAY TEST SHALL BE CONDUCTED AT THE FOLLOWING CONDITIONS : 样品按下列条件进行盐雾试验</p> <p>(1)DENSITY(浓度): 溶液(5±1)% NACL (质量百分比) (2)TEMPERATURE: 35±2°C 温度 (3) TIME: 24HOURS 时间</p>	<p>NO REMARKABLE CORROSION SHALL BE RECOGNIZED IN METAL PART 在金属上没有影响开关性能的斑点</p>

6. Welding Condition焊接条件:

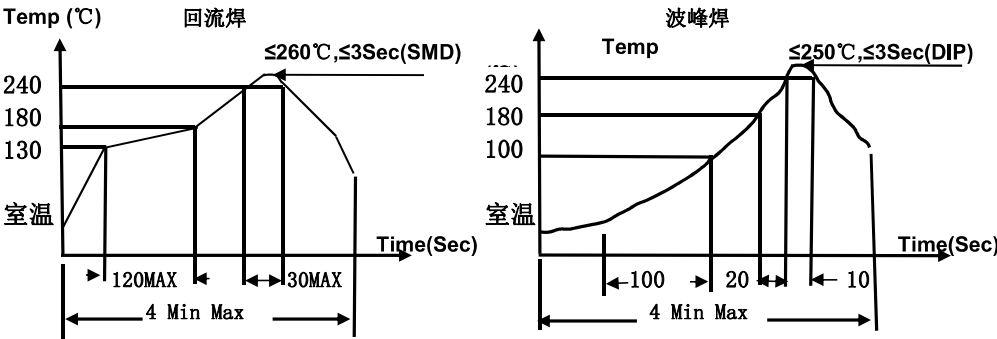
Item项目	Recommended conditions推荐条件
6.1	<p>For the product of Automatic flow soldering, type solder according to the following conditions 对于自动焊接产品, 请按以下条件进行焊接</p> <p>Temp (°C) 回流焊 波峰焊</p>  <p>Note: The above mentioned conditions are the temperature of the PWB surface on the part. Due to the PWB's material, size, thickness, etc., the temperature that the PWB will get from the switch surface will also vary greatly. Therefore, be careful not to let the switch Surface temperature exceeds 260 °C 注意: 以上提及的条件是零部件上PWB表面的温度, 由于PWB的材料、尺寸、厚度等不同, PWB从开关表面获得的温度也会有很大不同, 因此, 千万小心不要让开关表面温度超过260°C .</p>

规格承认书

SPECIFICATION FOR APPROVAL

Item项目		Test Method试验方法									
6.2	Hand soldering 手工焊接	<p>Please practice according to bellow conditions: (1)Soldering temperature :$\leq 250^{\circ}\text{C}$ (2)Continuous soldering time:$\leq 3\text{ S}$ (3)Power of ferrochrome:$\leq 30\text{ W}$</p> <p>请按以下条件进行焊接: (1)焊锡温度: $\leq 250^{\circ}\text{C}$ (2)连续焊接时间: $\leq 3\text{ S}$ (3)电烙铁的功率: $\leq 30\text{ W}$</p>									
6.3	Solder heat resistance (welding type application) 耐焊性(焊接型适用)	<p>(1) WAVE SOLDERING: $260\pm 5^{\circ}\text{C} \pm 1\text{SEC}$ MAX. (2) HAND WELDING: 360°C MAX. 3SEC. MAX.</p> <table border="1"> <thead> <tr> <th></th> <th>温度($^{\circ}\text{C}$) Temperature</th> <th>时间(S)Time</th> </tr> </thead> <tbody> <tr> <td>浸锡</td> <td>260 ± 5</td> <td>3 ± 1</td> </tr> <tr> <td>手焊</td> <td>350 ± 10</td> <td>1~3</td> </tr> </tbody> </table> <p>No abnormalities shall be observed in appearance and operation. No functional defective occur 无外观及功能损坏,无功能性不良.</p>		温度($^{\circ}\text{C}$) Temperature	时间(S)Time	浸锡	260 ± 5	3 ± 1	手焊	350 ± 10	1~3
	温度($^{\circ}\text{C}$) Temperature	时间(S)Time									
浸锡	260 ± 5	3 ± 1									
手焊	350 ± 10	1~3									

7.Other Precautions其他注意事项:

(1)Following the soldering process, do not try to clean the switch with a solvent or the like.

进行焊接过程中, 不可以用溶剂或类似品清洗开关

(2)Prevent flux from entering the mating clearance of the switch.

防止助焊剂从开关的配合间隙渗入

(3)If the solder, there is force in the terminal parts, then the terminal may be deformed and prone to poor electrical performance.

如果焊锡时, 有施力在端子部位的话, 则端子可能会变形且易出现电气性能不良。

(4)Soldering conditions should be confirmed according to the actual corresponding conditions.

焊锡条件应按照实际的对应条件予以确认。

(5)After delivery, the switch is sealed and the inventory time is below 90 days.

交货后保证开关处于密封状态并库存时间90天以下

(6)After the switch is soldered, do not operate the switch or perform secondary soldering with excess heat left.

开关被焊接后, 不要在留有余热的情况下操作开关或进行二次焊接。

规格承认书

SPECIFICATION FOR APPROVAL

8.GENERAL 通用

8.1 SCOPE 范围

This specification covers the requirements of all DIP and SMD switching series.

本规范涵盖了所有DIP和SMD开关系列的要求

8.2 PACKING MATERIAL 包装材料

8.2.1 Hand soldering

ITEM	SUBSTANCE
CARTON BOX 卡通箱	CORRUGATED PAPER 瓦楞纸
PACKING CTN 包装盒	CORRUGATED PAPER 瓦楞纸
PLASTIC BAG 塑料袋	NORMAL PLASTIC 普通塑料

① The capacity of packing ctn. 包装盒容量

Every carton box contains □ packing box at most. 每个外箱内最多包括 □个包装盒

② Every packing carton contains □K pcs goods at most. 每个包装盒内包括 □K pcs产品

③ Every plastic bag contains □ pcs 每个塑料袋容纳 □ pcs

8.2.2 Automatic flow soldering

ITEM	SUBSTANCE
PACKAGE 包装	CARTONS 卡通箱
REEL 转轴	DELETE CARTONS 可降解箱
CARRIER 载带	POLYPROPYLENE 聚丙烯

① The number of the reels. 转轴数量

□ reels at maximum. Which contain □K pcs switches

Shall be packed in a package. 一箱装□盘,有□K只产品

② The number of the switches. 产品数量

£K pcs switches shall be packed in a reel. 一个转轴包£K只产品

③ We need to be aware that two boxes are used for the export of products.

对出口产品需注意用两个箱子包装